

INSTRUCTION MANUAL

DC-90 Dust Collector (415V) 3200 cfm - LPHV System



W331

Save This Manual For
Future Reference

owners manual

Dust Collection System

**Serial
Number** _____

Model and serial number may be
found on the motor cover.

You should record both model and
serial number in a safe place for
future use.

CAUTION:
READ GENERAL and
ADDITIONAL SAFETY
INSTRUCTIONS
carefully.



DUST COLLECTION SYSTEM

- **assembly**
- **operation**
- **repair parts**

GENERAL SAFETY INSTRUCTIONS FOR POWER TOOLS

1. KNOW YOUR TOOL

Read and understand owners manual and labels affixed to the tool. Learn its application and limitations as well as its specific potential hazards peculiar to this tool.

2. GROUND THE TOOL

This tool is equipped with an approved 3-conductor cord and a 3-prong grounding type plug to fit the proper grounding type receptacle. The green conductor in the cord is the grounding wire. Never connect the green wire to a live terminal.

3. KEEP GUARDS IN PLACE

— in working order, and in proper adjustment and alignment.

4. REMOVE ADJUSTING KEYS AND WRENCHES

Form habit of checking to see that keys and adjusting wrenches are removed from tool before turning it on.

5. KEEP WORK AREA CLEAN

Cluttered areas and benches invite accidents. Floor must not be slippery due to wax or sawdust.

6. AVOID DANGEROUS ENVIRONMENT

Don't use power tools in damp or wet locations or expose them to rain. Keep work area well lighted. Provide adequate surrounding work space.

7. KEEP CHILDREN AWAY

All visitors should be kept a safe distance from work area.

8. MAKE WORKSHOP CHILD-PROOF

- with padlocks, master switches, or by removing starter keys.

9. USE PROPER SPEED

This tool will do the job better and safer when operated at the proper speed.

10. USE RIGHT TOOL

Don't force tool or attachment to do a job for which it was not designed.

11. WEAR PROPER APPAREL

Do not wear loose clothing, gloves, neckties or jewelry (rings wristwatches) to get caught in moving parts. Non-slip footwear is recommended. Wear protective hair covering to contain long hair. Roll long sleeves above the elbow.

12. USE SAFETY GOGGLES (Head Protection)

Wear safety goggles (must comply with ANSI Z87.1) at all times. Everyday eyeglasses only have impact resistant lenses, they are NOT safety glasses. Also, use face or dust mask if cutting operation is dusty, and ear protectors (plugs or muffs) during extended periods of operation.

13. DONT OVERREACH

Keep proper footing and balance at all times.

14. MAINTAIN TOOLS WITH CARE

Keep tools sharp and clean for best and safest performance. Follow instructions for lubrication and changing accessories.

15. DISCONNECT TOOLS

Before servicing, when changing accessories or attachments.

16. AVOID ACCIDENTAL STARING

Make sure switch is in OFF position before plugging in.

17. USE RECOMMENDED ACCESSORIES

Consult the owners manual for recommended accessories. Follow the instructions that accompany the accessories. The use of improper accessories may cause hazards.

18. NEVER STAND ON TOOL

Serious injury could occur if the tool tips over. Do not store materials such that it is necessary to stand on the tool to reach them.

19. CHECK DAMAGED PARTS

Before further use of the tool, a guard or other part that is damaged should be carefully checked to ensure that it will operate properly and perform its intended function. Check for alignment of moving parts, binding or moving parts breakage of parts, mounting, and any other conditions that may affect its operation. A guard or other part that is damaged should be properly repaired or replaced.

20. NEVER LEAVE MACHINE RUNNING UNATTENDED

Turn power OFF Don't leave Dust Collection System until it comes to a complete stop.

IMPORTANT SAFETY INSTRUCTIONS

When using your Dust Collection System, follow basic safety precautions including the following.

WARNING: to reduce the risk of fire, electric shock, or injury:

• Read and understand this owner's manual and all labels on the Dust Collection System before operating. Use only as described in this manual. To avoid personal injury or damage to Dust Collection System, use only recommended accessories.

Sparks inside the electrical parts, can ignite flammable vapors or dust. To avoid fire or explosion:

- Do not vacuum, or use this Dust collection System near flammable or combustible liquids, gases, gasoline or other fuels, lighter fluid, cleaners, oil-based paints, natural gas, hydrogen, or explosive dusts like coal dust, magnesium dust, grain dust, or gun powder.
- Do not vacuum anything that is burning or smoking, such as cigarettes, matches, or hot ashes.
- To avoid health hazards from vapors or dusts, do not vacuum toxic materials.
- Do not use or store near hazardous materials.
- Do not use outdoors or on wet surfaces.
- Put unit on a stable, level surface.
- Route vacuum hose and electric cord out of traffic areas.
- Do not allow to be used as a toy. Close attention is necessary when used by or near children.
- Do not leave appliance plugged in. Unplug from outlet when not in use and before servicing.

- To avoid injury from accidental starting, unplug power cord before changing or cleaning filter/dustbag or chip bag.

- Do not use without filter/dust bag and/or chip bag in place.

- Do not unplug by pulling on cord. To unplug, grasp the plug, not the cord.

- Turn off controls before unplugging.

- Do not use with damaged cord, plug or other parts, if your Dust Collection System is not working as it should, has missing parts, has been dropped, damaged, left outdoors, or dropped into water, return it to Service Center.

- Do not pull or carry by cord, use cord as handle, close a door on cord, or pull cord around sharp edges or corners. Do not run Dust Collection System over cord. Keep cord away from heated surfaces.

- Do not handle plug of the Dust Collection System with wet hands.

- Do not put any object into ventilation openings. Do not vacuum with any ventilation openings blocked; keep free of dust, lint, hair or anything that may reduce air flow.

- Keep hair, loose clothing, fingers, and all parts of body away from openings and moving parts.

- Extension cords in poor condition or that are too small can pose fire and shock hazards. When using an extension cord, be sure it is in good condition.

- Connect to properly grounded outlet only.

**SAVE THESE INSTRUCTIONS
FOR FUTURE REFERENCE**



CAUTION: If using this Dust Collection System to help keep airborne wood dust in heavy usage within acceptable limits, you must regularly monitor air borne dust and maintain Dust Collection System to avoid exceeding dust limits. Each application is unique. Your maintenance schedule must, therefore, be tailored to your specific use of this Dust Collection System.

Safety is a combination of common sense, staying alert and knowing how your Dust Collection System works.

BEFORE USING THE DUST COLLECTION SYSTEM:

WARNING: TO AVOID MISTAKES THAT COULD RESULT IN SERIOUS, PERMANENT INJURY, DO NOT CONNECT POWER CORD UNTIL THE FOLLOWING STEPS HAVE BEEN SATISFACTORILY COMPLETED:

1. Assembly, mounting and alignment.
2. Learn the function and proper use of the ON-OFF switch.
3. Read and understand all safety instructions and operating procedures throughout the manual.
4. Read the following labels which appear on the top and bottom of filtration housing.

WARNING	
	Metal shavings or dust can set sawdust on fire. Collect wood materials only. Do not collect metal shavings or dust. See manual for details.
	Risk of electrical shock. Use indoors in dry area. Do not use outdoors or on wet surfaces.
	Sparks can ignite vapors from flammable products. Do not use around flammable products.
If connected to a circuit protected by fuses, use time delay fuses with this appliance.	

WARNING	
	DO NOT OPERATE WITHOUT HOSE CONNECTED TO SUCTION CHUTE. HAZARDOUS MOVING PARTS INSIDE. UNPLUG BEFORE REMOVING INLET GUARD. ATTACH INLET GUARD BEFORE PLUGGING IN.

BEFORE EACH USE:

1. Inspect your Dust Collection System. If any parts are missing, bent, or fail in any way, or any electrical components do not work properly, turn off the Dust Collection System, and remove power supply cord from power supply. Replace damaged, missing or failed parts before using the Dust Collection System again.
2. Plan your work to protect your eyes, hands, face, ears and body.



A. WEAR SAFETY GOGGLES. FORESIGHT IS BETTER THAN NO SIGHT. Wear safety goggles, not glasses, that comply with ANSI Z87.1 (shown on label). Operating any power tool can result in foreign objects being thrown into the eyes which can result in permanent eye damage. Safety goggles are available at stores. Use of glasses or goggles not in compliance with ANSI Z87.1 could result severe in injury from breakage of the eye protection.

B. When cleaning collection bags, wear a dust mask.

CAUTION: The blower housing contains a high speed fan blade that can amputate fingers, grab loose clothing and neckties, or propel dust at high velocities. **DO NOT OPERATE WITHOUT ALL PARTS IN PLACE.**

Do not attempt to clean, remove dust bags or service unit while in operation. Disconnect from power source.

CAUTION: To avoid eye injury or adverse reaction to dust, high air pressure should not be used especially in poorly ventilated areas.

operation

POWER SUPPLY

⚠ WARNING: ALWAYS MAKE SURE THE VOLTAGE OF MOTOR AND MOTOR RATING AGREE WITH THE ELECTRICAL SYSTEM WHICH IS TO BE CONNECTED TO FOR YOUR DUST COLLECTOR OPERATION. CONNECT TO THE RIGHT ELECTRICAL SYSTEM AND USE TIME DELAY FUSE OR CIRCUIT BREAKER. FAILURE TO CONNECT IN THIS WAY CAN RESULT IN INJURY FROM SHOCK OR FIRE.

Your Dust Collection System must be properly grounded. Not all outlets are properly grounded. If you are not sure that your outlet is properly grounded, have it checked by a qualified electrician.

⚠ WARNING: IF NOT PROPERLY GROUNDED, THIS DUST COLLECTION SYSTEM CAN CAUSE ELECTRICAL SHOCK, PARTICULARLY WHEN USED IN DAMP LOCATIONS.

⚠ WARNING: TO AVOID SHOCK OR FIRE, IF POWER CORD IS WORN, CUT, OR DAMAGED IN ANY WAY, HAVE IT REPLACED IMMEDIATELY.

GROUNDING INSTRUCTIONS

This appliance must be grounded. If it should malfunction or breakdown, grounding provides a path of least resistance for electric current to reduce the risk of electric shock. This appliance is equipped with a cord having an equipment-grounding conductor and grounding plug. The plug must be plugged into an appropriate outlet that is properly installed and grounded in accordance with all local codes and ordinances.

⚠ WARNING: TO MAINTAIN PROPER DUST COLLECTION SYSTEM GROUNDING, WHENEVER THE OUTLET YOU ARE PLANNING TO USE FOR THIS POWER TOOL IS OF THE TWO PRONG TYPE, DO NOT REMOVE OR ALTER THE GROUNDING PRONG IN ANY MANNER.

EXTENSION CORDS (Example for Reference Only)

The use of any extension cord will cause some loss of power. Use the following table to determine the minimum wire size (A.W.G.) extension cord. Use only 3-wire extension cords which have 3-prong grounding type plugs and 3-pole receptacles which accept the tool's plug.

For circuits that are farther away from electrical circuit

This appliance is for use on a nominal 120-volt circuit, and has a grounded plug that looks like the plug illustrated below. A temporary adapter may be used to connect this plug to a 2-pole receptacle, as shown below, if a properly grounded outlet is not available. The temporary adapter should be used only until a properly grounded outlet can be installed by a qualified electrician. The green colored rigid ear, lug, or the like, extending from the adapter must be connected to a permanent ground such as a properly grounded outlet box cover. Whenever the adapter is used, it must be held in place by a metal screw.

WARNING: IMPROPER CONNECTION OF THE EQUIPMENT GROUNDING CONDUCTOR CAN RESULT IN A RISK OF ELECTRIC SHOCK. CHECK WITH A QUALIFIED ELECTRICIAN OR SERVICE PERSON IF YOU ARE IN DOUBT AS TO WHETHER THE OUTLET IS PROPERLY GROUNDED. DO NOT MODIFY THE PLUG PROVIDED WITH THE APPLIANCE IF IT WILL NOT FIT THE OUTLET, HAVE A PROPER OUTLET INSTALLED BY A QUALIFIED ELECTRICIAN.

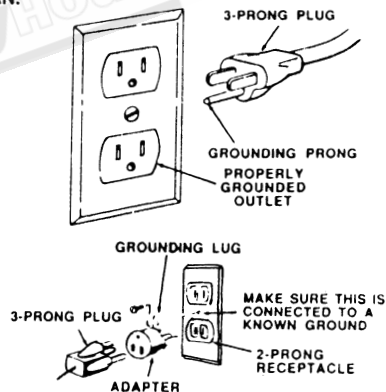

⚠ WARNING: THE ADAPTER ILLUSTRATED IS FOR USE ONLY IF YOU ALREADY HAVE A PROPERLY GROUNDED 2-PRONG RECEPTACLE.

NOTE: IN CANADA, THE USE OF A TEMPORARY ADAPTOR IS NOT PERMITTED BY THE CANADIAN ELECTRICAL CODE.

box, the wire size must be increased proportionately in order to deliver ample voltage to the saw motor.

Length of Conductor	Wire Sizes Required
	(American Wire Gage) 120V Lines
0 - 25 feet	No. 16
26 - 50 feet	No. 14
51 - 100 feet	No. 12

TROUBLESHOOTING NOTE: Motors used on wood-working tools are particularly susceptible to the accumulation of sawdust and wood chips and should be blown out or "vacuumed" frequently to prevent interference with normal motor ventilation and proper operation of the centrifugally-operated starting switch.

TROUBLE	POSSIBLE CAUSE	SOLUTION
Motor will not run.	1. Defective cord, plug switch, and/or motor. 2. Blown fuse or circuit breaker tripped.	1. Consult service. Any attempt to repair this motor may create a hazard unless repair is done by a qualified service technician. 2. Check for blown fuses and replace with fuse of proper capacity or re-set circuit breaker.
Excessive sawdust in air.	1. Loose clamps. 2. Dust bag and/or chip collection bag not secure	1. Tighten clamps.
Excessive impeller noise.	1. Picked up large chips and debris. 2. Loose impeller. 3. Rubbing impeller.	1. Stop the machine to allow material to fall to the bottom of inlet pipe. Remove debris. 2. Unplug unit prior to disassembly due to hazardous moving parts inside. Use a piece of wood to free impeller. Attach inlet guard before plugging in. 3. Consult service to repair loose or rubbing impeller. A repair to the housing may create a hazard unless it is done by a qualified service technician.
Excessive noise. Motor fails to develop; full power.	1. Motor. 2. Overloaded circuit. 3. Undersize extension cord or extension cord too long.	1. Have motor checked by qualified service technician. 2. Do not overload circuit when using dust collection system with other appliances. 3. Increase the wire sizes on extension cord, reduce length of extension cord or use larger wire sizes. Request a power check from the power company.
Motor starts slowly or fails to come up to full speed.	1. Low voltage. 2. Windings burned out or open. 3. Starting switch will not operate. (Switch contacts not working properly.)	1. Request voltage check from power company. 2. Have motor repaired or replaced by a qualified service technician. 3. Replace capacitor by a qualified service technician.
Motor overheats.	1. Motor overloaded. 2. Improper cooling. (Air circulation restricted through motor due to sawdust accumulation inside of motor.)	1. Clean out sawdust and provide normal air circulation through motor.
Motor stalls.	1. Low voltage does not permit motor to reach operating speed. 2. Fuses or circuit breakers lack sufficient capacity.	1. Request voltage check from power company. 2. Install proper size fuses or circuit breakers.
Frequent opening of fuses or circuit breakers.	1. Motor overloaded. 2. Fuses or circuit breakers lack sufficient capacity.	1. Install proper size fuses or circuit breakers.

MACHINE DATA

FAN DIAMETER	12 "
SOUNDRATING	65 - 80 DB
HOSE DIAMETER	4"×3 (8"×1)
AIR FLOW	1900 CFM
VELOCITY	10825 CFM
STATIC PRESSURE	10.2 INCH / WATER
BAG DIAMETER	20 "
COLLECTOR BAGS CAPACITY	10.68 CUBIC FEET
OVERALL DIMENSIONS.....	55-1/2"L×23"W×961/2"H
MOTOR.....	3 HP 1 Ph
.....	230 V
NET WEIGHT (APPROX).....	198 LBS
SHIPPING WEIGHT (APPROX).....	206 LBS

MACHINERYHOUSE

Unpacking

1. Finish removing all contents from the shipping carton.
2. Report any damage to your distributor.
3. Do not discard any shipping material until after the dust collector has been assembled and is running properly.

Contents of Shipping Container

- 1 Base
- 1 Fan/motor assembly
- 4 Caster assembly.
- 2 Housing support
- 2 Housing
- 2 Collector bag
- 2 Filter bag
- 2 Hanger bracket
- 4 Retainer strap
- 1 Connector tube
- 1 Hose adapter w/ caps
- 2 Upper hanger
- 2 Lower hanger
- 1 Bag of fasteners
- 1 Operator's manual

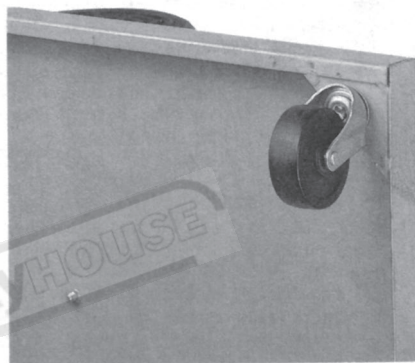

Tools Required for Assembly

- Adjustable wrench
- Combination wrench set (6mm-19mm)

Assembly

1. Remove nut and lock washer from caster shaft. Thread nut onto caster shaft and place lock washer over the nut. Insert assembly into tapped hole on underside of base. Repeat for other three casters. See Figure 1.
2. Turn base upright. Mount motor and intake assembly to base using hex bolts and 3/8" washers (six larger washers found in fastener package). Attach hose adapter to fan housing. See Figure 2.

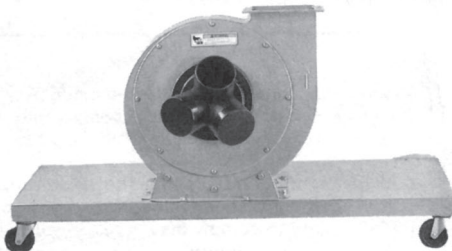

- 3 Attach connector tube to fan housing using hex head bolts, washers, and nuts. Be sure connector tube faces the proper direction, as shown in Figure 3.
- 4 Attach collector housings to collector tube with hex head bolts, washers, and nuts. Be sure that inside deflector of each housing spirals downward toward the collector bag. Check that holes in housings are on the same side as holes in base. See Figure 4.
- 5 Attach support brackets to base using hex head bolts and washers. Do not tighten at this time. Insert hanger brackets (A - Fig. 5) between support brackets and collector housings. Align holes and secure with hex head bolts, washers, and nuts. Use two washers per bolt -- both inside and outside the collector housing. Tighten all support bolts.
- 6 Thread a lower hanger into an upper hanger. Attach upper hanger bracket hook to a filter bag loop found on the top of the filter bag. Place the hanger into the hanger bracket. Slide a retainer strap through keepers and attach to the housing. Repeat for the other side. See Figure 6 (next page).
- 7 Slide retainer straps through keepers of collector bags and attach to collector housings. See Figure 7 (next page).

Electrical Connections

WARNING!

All electrical connections must be made by a qualified electrician. Failure to comply may result in serious injury!

All adjustments or repairs must be made with the dust collector disconnected from the power source. Failure to comply may result in serious injury!

Confirm that power at the source is compatible with the dust collector before making the electrical connections. The motor cord will have to be wired with a plug rated at 230V. The dust collector must

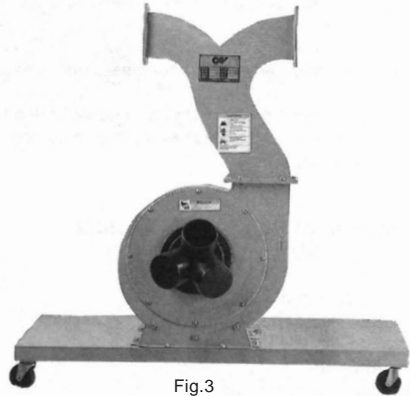

Fig.3

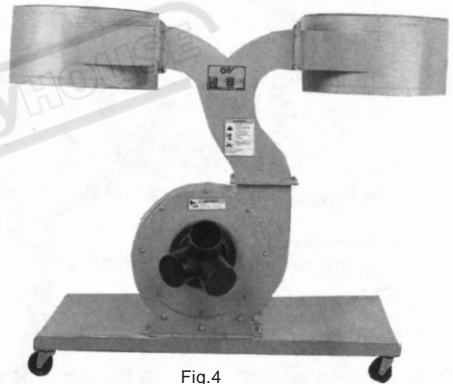

Fig.4

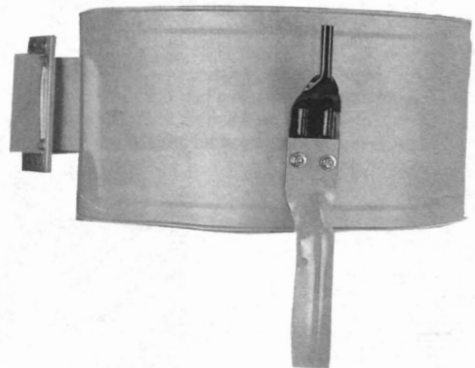

Fig.5

also be properly grounded through the electrical connection.

Before hooking up to the power source, make sure that the switch is in the off position.

Operational Hints

During first use and after cleaning, the filter bag may allow some dust to escape. This is normal and will stop after a short period of operation.

Caution:
Wearing a particle mask/respirator for protection against fine dust particles during cleaning is highly recommended.

Clean both filter and collector bags frequently to keep the collector's performance at its optimum. To clean:

- 1 Disconnect the machine from the power source.
- 2 Loosen the retaining strap, remove the bag from the housing, and empty contents.
- 3 Turn the bag inside out and shake vigorously.
- 4 Turn the bag outside in and re-attach to the housing using the retainer strap to secure.
- 5 Connect the machine to the power source.

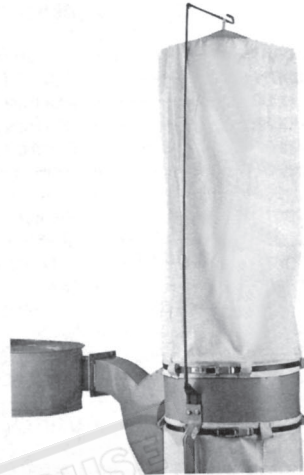

Fig.6

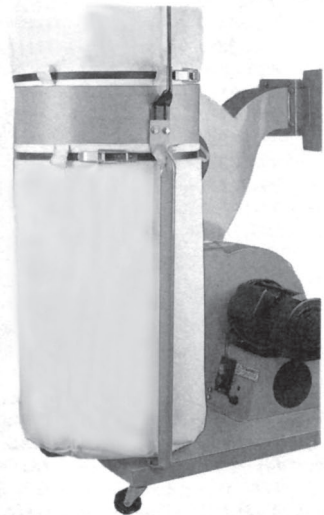
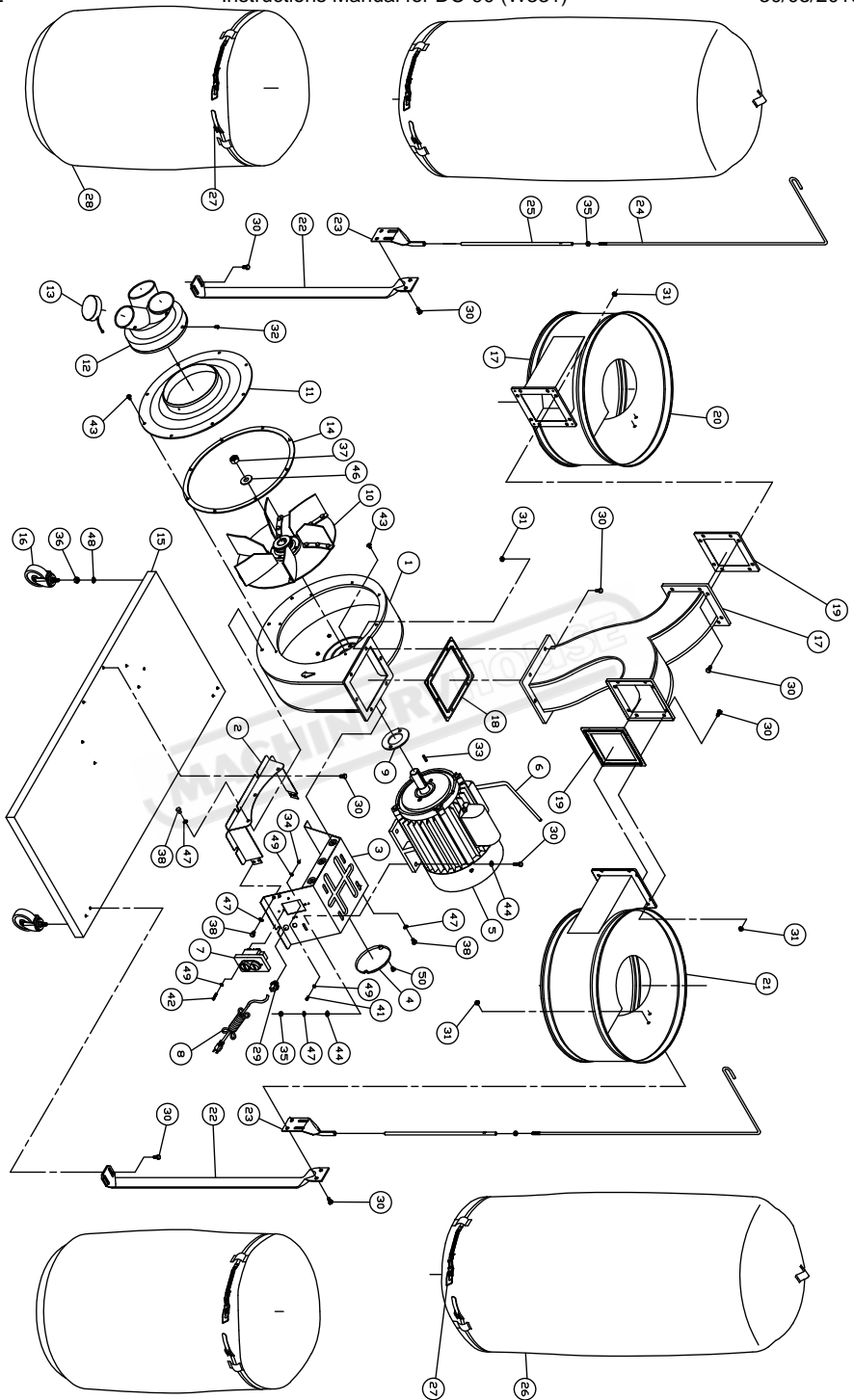
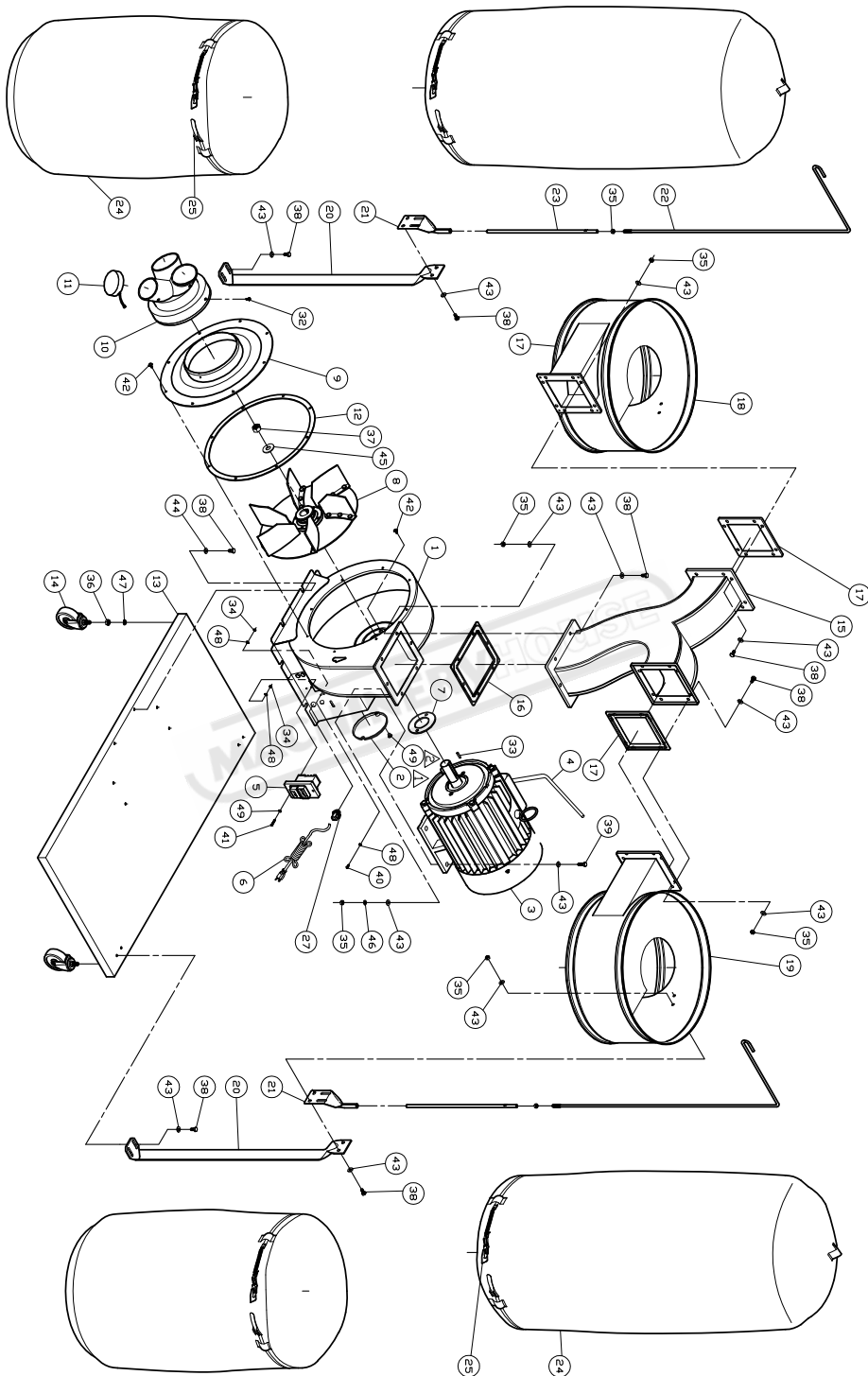

Fig.7



PARTS LIST				
KEY NO.	PARTS NO.	DESCRIPTION	SIZE	Q'TY
1	431018	IMPELLER HOUSING		1
2	431019	IMPELLER HOUSING BRACKET		1
3	431020	MOTOR BRACKET		1
4	459038	BRACKET CAP		1
5	MA431001	MOTOR	3HP	1
6	IM431001	MOTOR CORD	(OPTIONAL)	1
7	994542	SWITCH	(OPTIONAL)	1
8	IC431001	POWER CORD	(OPTIONAL)	1
9	420051	MOTOR PAD		1
10	AB431906	IMPELLER (ASM)	Ø14"	1
	431906	IMPELLER		1
	430007	BUSHING	Ø24	1
	SH089400	HEX HEAD BOLT	M8*16	4
	WS080000	SPRING WASHER	M8*16	4
11	431008	INLET COVER	Ø8"	1
12	431025	ADAPTER	3-Ø4"	1
13	420203	ADAPTER CAP		2
14	431034	INLET COVER PACKING		1
15	430028	BASE		1
16	402036	PIVOTING CASTER		4
17	430004	CONNECTOR		1
18	430035	RUBBER PACKING		1
19	430036	RUBBER PACKING		2
20	430002	LEFT HOUSING		1
21	430030	RIGHT HOUSING		1
22	402004	SUPPORT BAR		2
23	523011	HANGER BRACKET		2
24	430053	UPPER HANGER		2
25	424008	LOWER HANGER		2
26	430055	FILTER BAG		2
27	AB430005	RETAINER STRAP		4

PARTS LIST				
KEY NO.	PARTS NO.	DESCRIPTION	SIZE	Q'TY
	430005A	STEEL STRAP		1
	430005B	BACKLER HOLER		1
	430005C	BACKLER		1
	430005D	HOOKLY HOLDER		1
	430005E	HOOKLY		1
	VF050035	RIVET	Ø5*3.5L	2
	VF050280	RIVET	Ø5*28	1
28	402018	COLLECTION BAG		2
29	998654	STRAIN RELIEF		2
30	SG080400	HEX HEAD BOLT W/FLANGE	M8*20	40
31	NF081300	HEX FLANGE NUT	M8	30
32	SF550400	PAN HEAD BOLT W/FLANGE	3/16"*1/2"	1
33	KS070720	KEY	7*7*20	1
34	NH550800	NUT	3/16"	1
35	NH081300	NUT	M8	6
36	NH581400	NUT	3/8"*16UNC	4
37	NH602300	NUT	5/8"*18UNF	1
38	SH089300	HEX HEAD BOLT	M8*12	12
41	SP550400	PAN HEAD BOLT	3/16"*1/2"	1
42	SP551000	PAN HEAD BOLT	3/16"*1"	2
13	SF069300	PAN HEAD FLANGE BOLT	M6*12	10
44	WF081818	FLAT WASHER	M8*Ø18	8
46	WF164030	FLAT WASHER	M16*Ø40	1
47	WS080000	SPRING WASHER	M8	14
48	WS100000	SPRING WASHER	M10	4
49	WE050000	STAR WASHER (EXT.)	M5	4
50	ST049200	TAPPING SCREW	M4*8	2



PARTS LIST				
KEY NO.	PARTS NO.	DESCRIPTION	SIZE	Q'TY
1	AB431916	IMPELLER HOUSING		1
	431916	MOTOR BRACKET		1
	431917	MOTOR BRACKET		1
	431918	IMPELLER HOUSING		1
	431019	IMPEELER HOUSING BRACKET		1
2	459038	BRACKET CAP		1
3	MA435001	MOTOR	5HP 3PH	1
4	IM435001	MOTOR CORD	(OPTIONAL)	1
5	994543	SWITCH	(OPTIONAL)	1
6	IC435001	POWER CORD	(OPTIONAL)	1
7	420051	MOTOR PAD		1
8	AB431006	IMPELLER (ASM.)	Ø14"	1
	431006	IMPELLER		1
	430007	BUSHING	Ø24	1
	SH089400	HEX HEAD BOLT	M8*16	4
	WS080000	SPRING WASHER	M8	4
9	431008	INLET COVER	Ø8"	1
10	431025	ADAPTER	3-Ø4"	1
11	420203	ADAPTER CAP		2
12	431034	INLET COVER PACKING		1
13	430028	BASE		1
14	402036	PIVOTING CASTER		4
15	430004	CONNECTOR		1
16	430035	RUBBER PACKING		1
17	430036	RUBBER PACKING		2
18	430002	LEFT HOUSING		1
19	430030	RIGHT HOUSING		1
20	402004	SUPPORT BAR		2
21	523011	HANGER BASKET		2
22	430053	UPPER HANGER		2
23	424008	LOWER HANGER		2

PARTS LIST				
KEY NO.	PARTS NO.	DESCRIPTION	SIZE	Q'TY
24	430001	FILTER BAG		2
25	AB430005	RETAINER STRAP		4
	430005A	STEEL STRAP		1
	430005B	BACKLER HOLER		1
	430005C	BACKLER		1
	430005D	HOOKLY HOLDER		1
	430005E	HOOKLY		1
	VF050035	RIVET	Ø5*3.5L	2
	VF050280	RIVET	Ø5*28	1
26	402011	COLLECTION BAG		2
27	998654	STRAIN RELIEF		2
32	SF550400	PAN HEAD BOLT W/FLANGE	3/16"*1/2"	1
33	KS070720	KEY	7*7*20	1
34	NH550800	NUT	3/16"	1
35	NH081300	NUT	M8	32
36	NH581400	NUT	3/8"*16UNC	4
37	NH602300	NUT	5/8"*18UNF	1
38	SH080400	HEX HEAD BOLT	M8*20	36
39	SH080500	HEX HEAD BOLT	M8*25	4
40	SP550400	PAN HEAD BOLT	3/16"*1/2"	1
41	SP551000	PAN HEAD BOLT	3/16"*1"	2
42	SH069300	PAN HEAD BOLT W/FLANGE	M6*12	10
43	WF081818	FLAT WASHER	M8*Ø18	64
44	WF081818	FLAT WASHER	M8*Ø18	6
45	WF164030	FLAT WASHER	M8*Ø40	1
46	WS080000	SPRING WASHER	M8	4
47	WS100000	SPRING WASHER	M10	4
48	WE050000	STAR WASHER (EXT.)	M8	4
49	ST049200	TAPPING SCREW	M4*8	2

***owners
manual***

SERVICE

**Dust Collection
System**

**HOW TO ORDER
REPAIR PARTS**

DUST COLLECTION SYSTEM



WHEN ORDERING REPAIR PARTS, ALWAYS
GIVE THE FOLLOWING INFORMATION:

PART NUMBER PART DESCRIPTION

MODEL NUMBER NAME OF ITEM